

R3

OPERATIVA

Novo  forma

S I S T E M A S



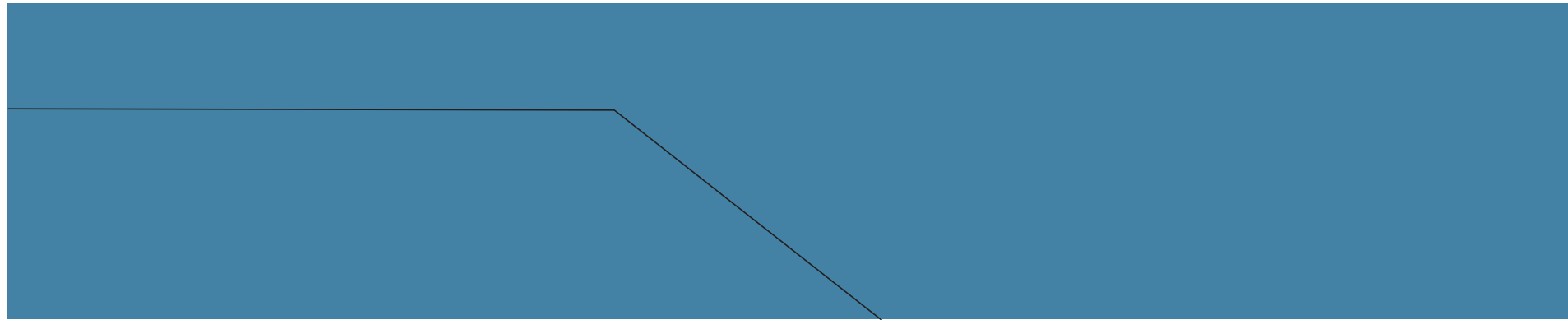

Encimera de mesa de MDF de 1,9 cm de espesor. Cantos biselados y lacados.

Table top in 1,9 cm MDF, with lacquered and bevelled edges.

Plateau de table fabriqué en MDF de 1,9 cm d'épaisseur, chants biseautés et laqués.

Tampo de mesa de MDF com 1,9 cm de espessura, cantos biselados e lacados



004 | R3
NOVOFORMA

005 | R3
NOVOFORMA

simplicidad de formas

diseño novoforma

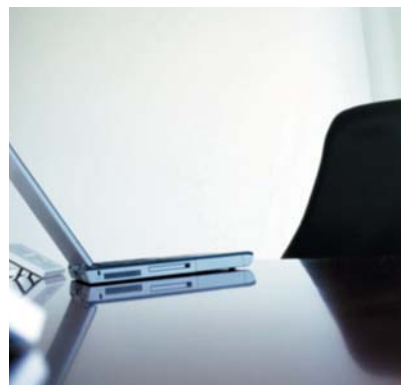

MESAS
RECTANGULARES

R3
OPERATIVA

Pies de mesa metálicos de 2 mm de espesor acabados en gris aluminio (RAL 9006) o en blanco polar (RAL 9010), con niveladores de altura de 1.5 cm de regulación.

2 mm metal table legs, finished in aluminium grey (RAL 9006) or in polar white (RAL 9010), with 1.5 cm height levelers.

Piedments métalliques avec 2 mm d'épaisseur, finition gris aluminium (RAL 9006) ou blanche (RAL 9010), avec nivelateurs avec 1.5 cm de régulation.



Una propuesta práctica y funcional

diseño novoforma

Encimeras de mesa de 2.5 cm. de espesor, con cantos rectos de ABS de 2 mm. de grosor.

Table tops with 2.5 cm. thickness boards, and 2 mm. ABS straight edges.

Plateau de table fabriqué avec tableaux agglomérés de 25 mm d'épaisseur. Bords droits d'ABS de 2 mm d'épaisseur.

simplicidad de formas



Pies metálicos rectangulares de acero laminado en frío con medida 60 x 30 x 1,5 mm. Bastidor de mesa extensible de 1200 a 2000 mm.

Rectangular metal legs made in 60 x 30 x 1,5 mm. cold rolled steel. Extensible table frame from 1200 to 2000 mm.

Pieds de table rectangulaires fabriqués avec acier de 60 x 30 x 1,5 mm. laminé à froid. Poutre de table extensible de 1200 à 2000 mm.

Pés rectangulares de aço de 60 x 30 x 1,5 mm. laminado em frio. Bastidor de mesa extensível de 1200 a 2000 mm.

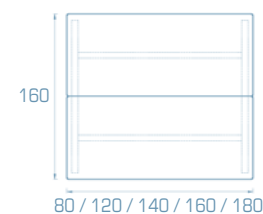

Líneas rectas la distancia más corta

diseño novoforma

Roscas metálicas para acoples de mesa. Aristas redondeadas a partir de un radio de 20 mm.

Metal threads. Rounded feathering based on a 20 mm radius.

Filets métalliques. Arêtes arrondies à partir d'un rayon de 20 mm.

Roscas metálicas. Arestas arredondado a partir de um raio de 20 mm.

R3
OPERATIVA

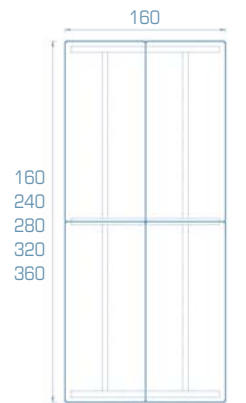

OIO | **R3**
NOVOFORMA

OIO | **R3**
NOVOFORMA



adaptable a todas las necesidades

diseño novoforma



OIB | R3
NOVOFORMA

Mostrador de altura 110 cm. Encimera opcional de cristal templado de 8 mm de grosor, superpuesta

110 cm high desk counters. Optional over framed 8 mm thickness glass tops

Banques d'accueil avec 110 cm d'hauteur. Option de tablettes supérieures en verre dépoli épaisseur 8 mm, superposés.

RECEPCIONES

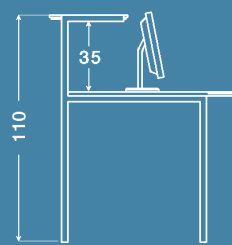

MOSTRADOR BAJO 110 CM
110 CM HIGH DESK COUNTERS
HAUTEUR TOTALE: 110 CM



- Ⓐ MOSTRADOR RECTO INDIVIDUAL
- Ⓑ MOSTRADOR CURVO INDIVIDUAL
- Ⓒ MOSTRADOR RECTO DE PROLONGACIÓN
- Ⓓ MOSTRADOR CURVO DE PROLONGACIÓN
- Ⓔ MOSTRADOR ESQUINERO DE UNIÓN
- Ⓕ MOSTRADOR DE UNIÓN CON ACCESO A MINUSVALIDOS.

soluciones sencillas para problemas complejos

diseño novoforma

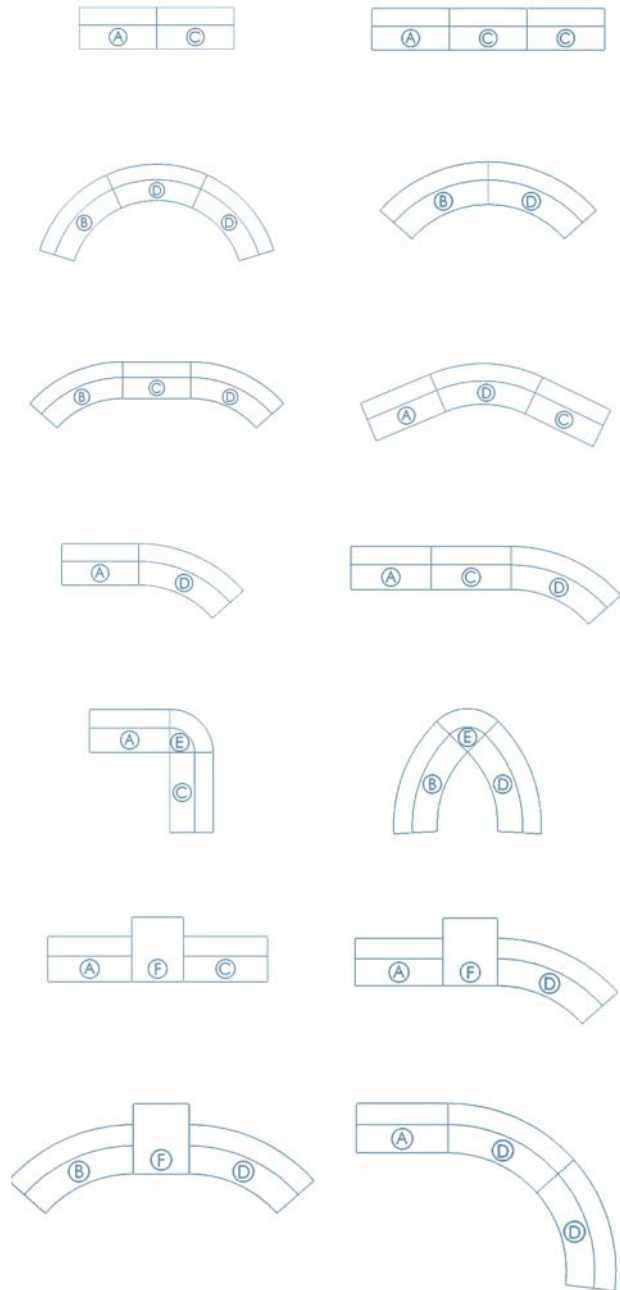



ⓔ MOSTRADOR ADAPTADO PARA LA ATENCIÓN A MINUSVÁLIDOS
COUNTER MODULE SUITABLE FOR HANDICAPED PEOPLE ATTENTION.
COMPTOIR ADAPTÉ POUR L'ATTENTION DES HANDICAPÉS.
MOSTRADOR ADAPTADO PARA ATENDIMIENTO DE DEFICIENTES.

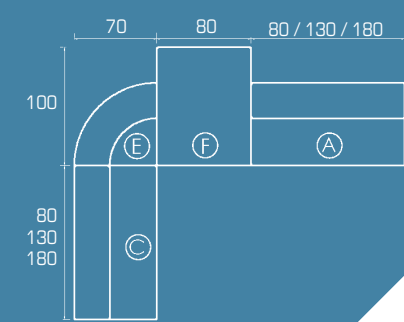

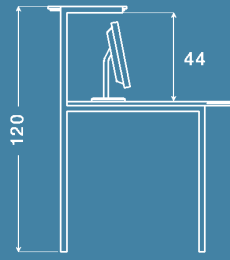

MOSTRADOR ALTO 120 CM
120 CM HIGH DESK COUNTERS
HAUTEUR TOTALE: 120 CM

soluciones sencillas para problemas complejos

diseño novoforma

OIB | IR3
NOVOFORMA

Mostrador de altura 120 cm. Encimera opcional de cristal templado de 8 mm de grosor - encastrada

120 cm high desk counters. Optional embeded 8 mm thickness glass tops

Banques d'accueil avec 120 cm d'hauteur. Option de tablettes supérieures en verre dépoli épaisseur 8 mm, encastrés



elegancia y pureza de líneas

diseño novoforma

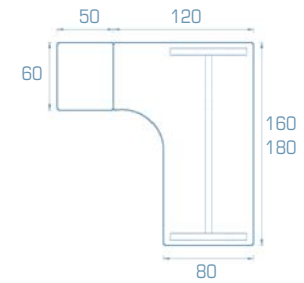

020 | R3
NOVOFORMA

021 | R3
NOVOFORMA

022 | RB
NOUVEAU

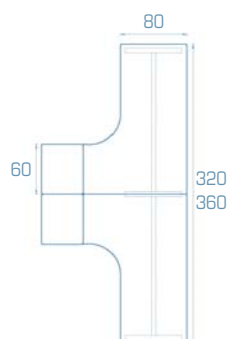

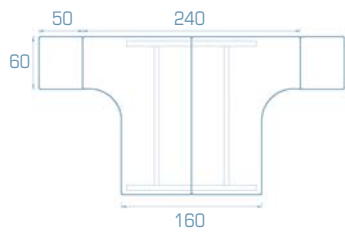

elegancia y pureza de líneas

diseño novoforma

Tableros recubiertos de estratificado de baja presión, con gramaje de $\pm 120 \text{ g/m}^2$.

Boards covered in low-pressure laminate, with a grammage of $\square 120 \text{ g/m}^2$.

Tableaux recouverts de stratifié de basse pression avec un grammage de $\square 120 \text{ g/m}^2$.

Tamos recoberto de estratificado de baixa pressão com gramagem de $\square 120 \text{ g/m}^2$.

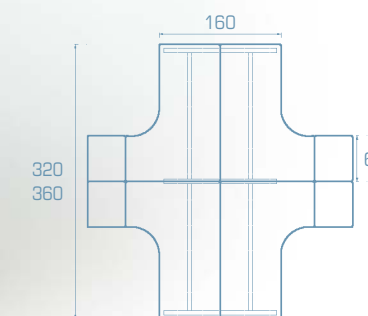

Disponemos de una amplia variedad de armarios de 3 alturas: 74 cm., 160 cm. y 200 cm. y dos anchuras diferentes: 90 cm. y 45 cm., con la posibilidad de incorporar puertas batientes, puertas correderas, archivadores, vitrinas con marco de madera y vitrinas con marco de aluminio.

Ofrecemos además módulos de estanterías autoportantes de 220 cm. de alto y 90 cm. de ancho. Incorporamos a su vez un innovador armario de 160 cm. de altura con dos módulos laterales de 45 cm. de ancho y un módulo central de 90 cm. de ancho, con dos vitrinas correderas con marco de aluminio de 45 cm. de ancho cada una.

We offer a wide range of cabinets, either 74 cm., 160 cm. or 200 cm. height, and either 90 cm. or 45 cm. width. They can also have either hinged doors, sliding doors, or filing drawers, with the possibility of adding glass doors with wooden frame or aluminium frame.

220 cm. height self-standing shelf modules are also available in this line. We introduce as well an innovative cabinet 160 cm. height, with two lateral modules of 45 cm. width, plus a central module 90 cm. width, with two sliding aluminium framed glass doors 45 cm. width each.

Nous avons une vaste variété d'armoires en 3 hauteurs: 74 cm., 160 cm. et 200 cm., ainsi que 2 largeurs différentes: 90 cm. et 45 cm., avec la possibilité d'incorporer des portes battantes, des portes coulissantes, tiroirs pour dossiers suspendus, des portes vitrées avec le cadre en bois ou avec le cadre en aluminium.

Également nous avons des modules de rayonnage autoportantes de 220 cm. de hauteur et 90 cm. de largeur. Nous avons incorporé aussi une armoire complètement innovatrice de 160 cm. de hauteur avec 2 modules latéraux de 45 cm. de large et un module central de 90 cm., avec 2 portes vitrées coulissantes de 45 cm. de large et cadre d'aluminium.



ARMARIOS
funcionalidad y
armonía
diseño novoforma

ACABADOS
FINISHINGS
FINITIONS
ACABAMENTOS



wengué
wengue
wengue
wengue



teka
teak
teck
teca



haya
beech
hêtre
faia



arce
maple
érable
bordo

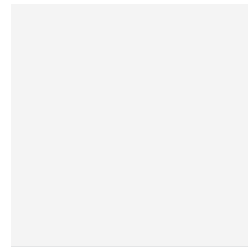

blanco
white
blanc
branco

mesas rectangulares

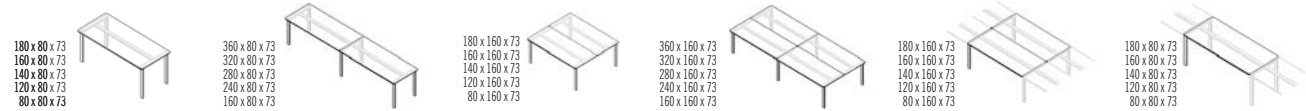

mesas compactas



alas de mesa



bucs de ruedas



bucs pedestales

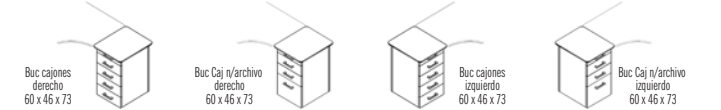

pie individual



soporte colgante para cpu



mesas de juntas



mostradores individuales

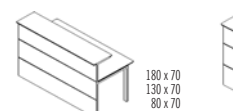

mostradores de prolongaci n



mostradores de uni n



armarios

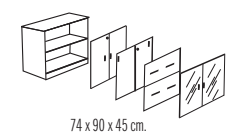
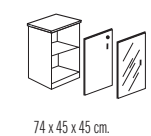
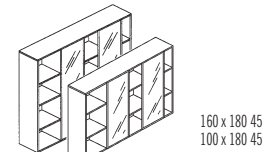
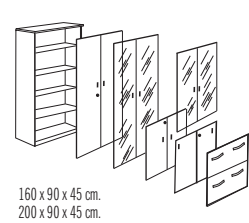
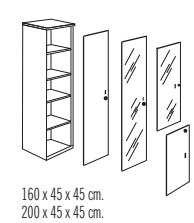



Novoforma sistemas s.a.
Tfno. 942 52 01 12 • Fax: 942 52 01 61
www.novoforma.com ✉ info@novoforma.com
Carretera General s/n.
39718 Sobremazas (Cantabria)
SPAIN